

FREE

# MARINE INDUSTRY NEWS

FOR THE MARINE TRADE | JANUARY 2023 | ISSUE 06

**IN THIS ISSUE...**

 <b>4</b>	 <b>8</b>	 <b>19</b>
<b>POWER PLAY</b> Spirit Yachts on its clean energy drive	<b>STOCK REPORT</b> Market gains in Asia and the Middle East	<b>NEW REALITY</b> Boatbuilders using virtual reality

[marineindustrynews.co.uk](http://marineindustrynews.co.uk)



## SeaDek®

Marine Non-Skid PE/EVA Decking · Custom Designs Available · DIY Sheets for Self-Cut and Install  
3M™ Peel-and-Stick Application · Great Wet/Dry Traction for the Harshes Marine Conditions  
Custom Cut Deck Grip Tapes Available · On-Site Installation Service Available

[www.seadekpro.uk](http://www.seadekpro.uk) | [info@seadekpro.uk](mailto:info@seadekpro.uk)



**SBS BoatLife**  
GREAT BRITISH BOAT TRAILERS  
NEC | Birmingham | 16-19 February 2023

VISIT US AT STAND G38!

News and industry insights for marine professionals - subscribe to the daily newsletter





TM

# Aquafax

**The UK's distributor of choice for marine & industrial equipment**

Aquafax are proud to be the preferred UK distributor for Lowrance® & B&G®

INTRODUCING  
**HDS<sup>®</sup> PRO**



**SEE MORE,  
CATCH MORE**

HDS<sup>®</sup> PRO sets a new standard for underwater visibility. Get the highest resolution live sonar with **ActiveTarget 2<sup>®</sup>**. And ultra high definition clarity in the Megahertz range with new **Active Imaging™ HD**.

Bow-to-stern boat control with the **Ultimate Fishing System**, and detailed **C-MAP<sup>®</sup>** charting make **HDS<sup>®</sup> PRO** the most powerful fishfinding tool available.

**LOWRANCE<sup>®</sup>**  
www.lowrance.com

©Reg. U.S. Pat. & Tm. Off. and ™ common law marks. Visit [www.navico.com/intellectual-property](http://www.navico.com/intellectual-property) to review the global trademark rights and accreditations for Navico Holding AS and other entities.

*SAILING, SIMPLIFIED*



**NEW ZEUS<sup>®</sup> S**  
AVAILABLE IN 7", 9" & 12"

Zeus S is designed for simplicity. It all starts with brand new Sailing Modes for Cruising and Racing. Get instant access to all the right data for your situation.

Zeus S also brings updates and additions to B&G's award-winning sailing features like C-MAP<sup>®</sup>-powered Safety Alerts, race routes, Laylines and SailSteer™.

On-board navigation is taken care of by the highly-accurate C-MAP DISCOVER™ X and REVEAL™ X charts, and our intuitive new interface and Setup Wizard get you connected to all your on-board electronics in minutes.

**B&G<sup>®</sup>**  
Marine Electronics for Sailing



www.bandg.com

Visit us at BoatLife to see how we can assist with your business requirements  
**Stand C63 | 16-19 February 2023**



For more information please visit [www.aquafax.co.uk](http://www.aquafax.co.uk)





For boatbuilders, distributors, manufacturers, and all marine trade professionals.

**DAILY NEWSLETTER**

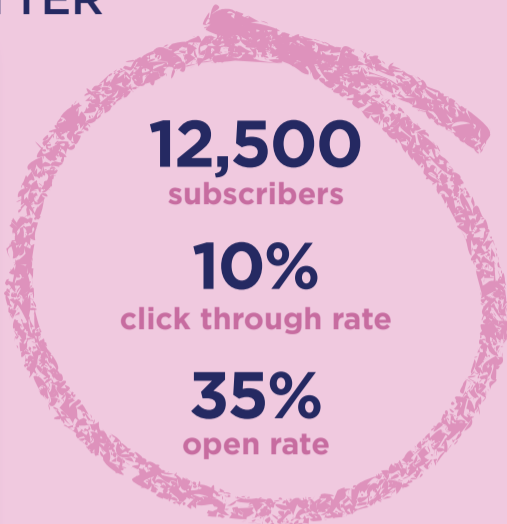

**WEBSITE**



**READERSHIP**

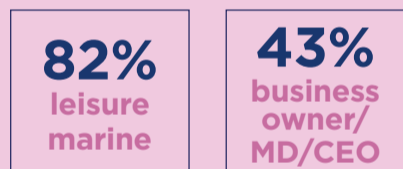

**SOCIAL MEDIA**



Scan here for our **rate card**



Scan here to subscribe to our **daily news**



Marine Industry News next issue available at **Palma Boat Show** - contact: [lyndsay@marineindustrynews.co.uk](mailto:lyndsay@marineindustrynews.co.uk) [jake.young@marineindustrynews.co.uk](mailto:jake.young@marineindustrynews.co.uk) to book your space. Ad deadline 12th April.



**Editorial**  
**MIN daily news, website/print edition**  
 Editor - Chantal Haines  
[chantal@maa.agency](mailto:chantal@maa.agency)  
 Deputy Editor - Susannah Hart  
 Managing Editor - Zella Compton  
[info@marineindustrynews.co.uk](mailto:info@marineindustrynews.co.uk)

**Advertising**  
 Commercial Manager  
**Lyndsay McClay**  
[lyndsay@marineindustrynews.co.uk](mailto:lyndsay@marineindustrynews.co.uk)

Database Marketing and Sales Executive  
**Jake Young**  
[jake.young@marineindustrynews.co.uk](mailto:jake.young@marineindustrynews.co.uk)  
 Designed by Steven David Davies  
[steve@maa.agency](mailto:steve@maa.agency)

Units SF1-2  
 Endeavour Quay  
 Mumby Road  
 Gosport  
 PO12 1AH UK  
[www.marineindustrynews.co.uk](http://www.marineindustrynews.co.uk)  
 © Marine Advertising Agency Ltd (MAA)

Printed by Stanbury Chameleon  
 on Carbon Balanced Paper,  
 endorsed by the  
 World Land Trust

**CONTENTS**

- 04 POWER PLAY**  
 Spirit Yachts reveals why re-gen electric options and solar sails are the future.
- 08 STOCK REPORT**  
 How the leisure marine business is evolving in Asia and the Middle East.
- 15 ON THE HORIZON**  
 Barton Marine's CEO lifts the lid on navigating Brexit and the firm's US expansion.
- 19 NEW REALITY**  
 Does virtual and augmented reality hold the key to boat design and marketing?
- 22 TOP GEAR**  
 New innovations for the leisure marine market and industry-leading products.



At the turn of the year, I was chatting with a manufacturer about the months ahead and he reflected “we simply must never stand still”.

Whether it's new innovations, a push for electric or hybrid power and further sustainability, or expanding a business footprint, many in the trade have the same view. While global economic and political factors are a constant consideration, progress and new developments still stir up exciting prospects across the sector.

In this issue of *MIN* magazine, we look at how boatbuilders and OEMs are utilising augmented reality to improve production processes and how virtual reality could change the owner experience (page 19). UK boatbuilder Spirit Yachts opens its doors to *MIN* on page 4 to talk solar sail technology and how it's feeding customer appetite for re-gen electric power options. While on page 8, we are on the ground in China and the UAE, with the latest on marina developments and market reaction to Europe's current state of play.

Do drop in and connect with the *MIN* team at the upcoming trade events and boat shows - we look forward to seeing you and reporting on what is to come in 2023.

*Chantal*



## Renowned UK boatbuilder Spirit Yachts lifts the lid on its clean energy drive, and its customers' appetite for re-gen electric power options and solar sails

During Southampton International Boat Show 2022 Sean McMillan, founder of Spirit Yachts, announced that more than half the boats on order with the company were repeat orders for existing owners, but each repeat order owner was moving from diesel to electric. This obviously delighted him. It's no industry secret that Spirit has been pushing hard on the sustainability agenda since it won British Marine's inaugural environmental award at SIBS 2019. And, in a recent BBC documentary (*Making Waves: Building Boats*), McMillan lost no time in disparaging the state of the UK's boat production.

"Look at this," he said, gazing over a marina, the likes of which can be seen around the UK. "I find this really depressing. Acres and acres of white fibreglass.

"The problem with marinas like this is that 99 per cent of the boats in them are made from

fibreglass. It's leaving behind a really appalling legacy. Some of them might last 20/30 years but by that stage they'll be very tired. It is indefensible and it cannot go on."

Without having to contend with the environmental issues of GRP – all Spirit Yachts are made with sustainably sourced wood (primarily Douglas Fir and Sapele from Canada) – the company is focusing its attention on re-genning clean energy used for the hotel load (interior lights etc), and electric propulsion.

### Re-gen revolution

In April 2021, Karen Underwood was appointed Spirit's MD and handed the baton for delivering even more effective, efficient propulsion systems on the high-end yachts beloved of James Bond film directors. She has a clear direction for the future. "Fundamentally we'd hope that any sailing yacht coming out of here would be having

an electric drive system onboard," says Underwood.

"As an industry we need to be hitting global environmental targets and promote and facilitate the use of electric drive yachts. We need to be efficient in regeneration and power management, lowering the carbon footprint and having less of an impact on the environment. That's where we all really need to be. And that's what's reflected in our yard. It's something I can say, but it's also something we can back up."

That back up comes with an impressive legacy borne out of a desire to innovate, and clients' interest in sustainable yachts. Underwood details *Avvento*; the owner lives totally off-grid in Canada in his electric 44CR (cruiser-racer design), built in the Ipswich yard in 2020. As well as an Oceanvolt sail drive system to generate power (through the propeller) while

sailing, deck solar panels and a small wind turbine to make the boat as self-sufficient as possible, *Avvento* features flexible solar panels attached to the mainsail for maximising solar energy.

"The panels are all either sewed in or glued onto the sail," Underwood says. At the time Spirit was suggesting (and embracing) this technology, it was almost unheard of. "Solar technology has definitely advanced and so we can shape the solar panels to capture sunlight to convert into energy at particular times of the day," says Underwood.

"The owner of *Avvento*, is now working with OneSails' John Parker and saying 'actually at this time of day I could have captured the sun when it was lower to the water – could we look at having a different shape, or size of panel?' He's working with OneSails directly, and with us, to have best use of the solar panels."



As well as an Oceanvolt sail drive system to generate power (through the propeller) while sailing, deck solar panels and a small wind turbine, *Avvento* features flexible solar panels attached to the mainsail.

Spirit 44 Avvento

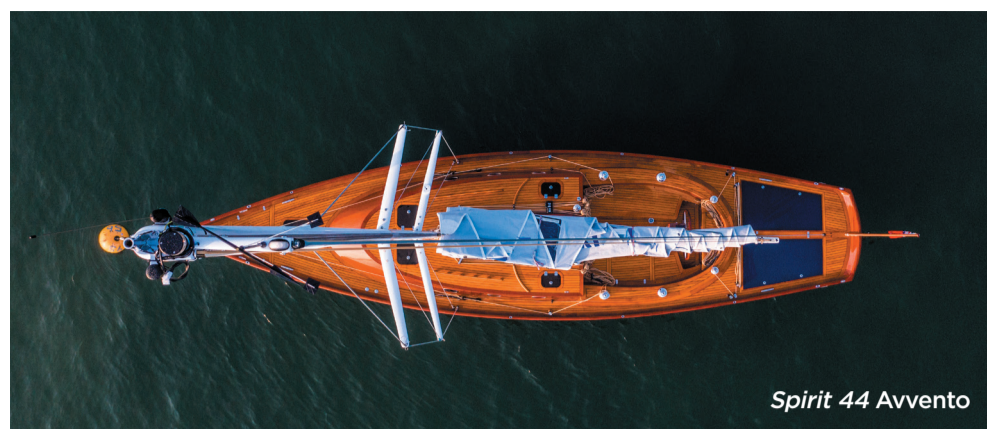

Spirit 44 Avvento

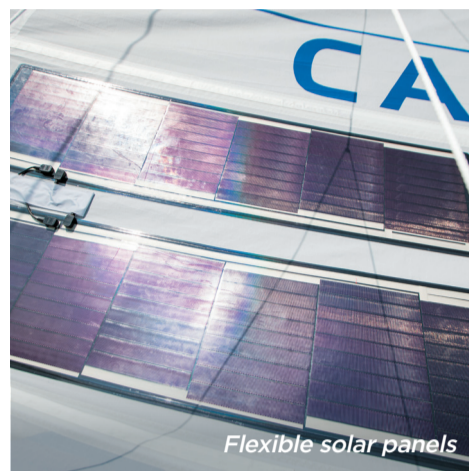

Flexible solar panels



Mahogany and stainless-steel steering wheel



Integrated solar panels



Karen Underwood



James Weller

As James Weller, Spirit's head electrician, notes there is currently a significant cost in choosing electric over diesel. "The more it's adopted, the more the price will come down," he says pragmatically. He is a keen advocate of re-gen technology.

"Solar is currently the best way of continually charging the system," Weller says. "Modern panels are getting more and more efficient even on a cloudier day. But when you're sailing, if you get prime conditions, you can really put a decent amount of power back into the yacht by using the re-gen through the propeller."

While Weller is keen to stress that standalone data can be misleading as factors like the weather

conditions and handling will affect that re-gen capacity, he says that, in great conditions sailing for an hour, he witnessed an average of 900 watts continuously being put back into the system.

Spirit is currently working with a few suppliers of re-gen technology and electric propulsion, testing new systems before fully committing. Currently in the mix is Torqeedo, Oceanvolt and lately ePropulsion (destined for the second Spirit 30).

"We can't afford to be totally wedded to one supplier because of what's going on in the world at the moment," says Underwood. "Some owners like to keep all systems the same, other times they don't. Some of our owners get

incredibly involved with the supply element and deal directly with the manufacturers, which is great because we can all liaise together and there's no mismanagement in the communication. It also means we're pushing the supplier. We're pushing boundaries all the time."

Weller agrees: "We're trying to make it so that their products are better, which purely makes our products better. We're always trying to get suppliers to make their product as good as possible as they're attached to our product. For example, we've done design tweaks with Oceanvolt regarding its installations and its battery management system, even down to the lighting on its throttles and how that's programmed. It's lots of little modifications that all add up."

**Adapting to change**

According to Underwood, Weller does a lot of R&D (mathematical problem solving) with suppliers and clients and has - over the past 21 years - become the 'go to' centre of knowledge on the East Coast for re-gen and drive tech advice.

Now Spirit is moving towards using MG Batteries. Underwood cites their performance on the P70 powerboat as being instrumental

for making the decision, as well as the fact that "they work really nicely with the rest of the system."

But while Spirit is openly advocating re-gen and electric drives, both Underwood and Weller note that not all owners are so open to moving away from fossil fuels. "I think it's about changing perceptions, exploring avenues and spending time with people such as James who knows what he is talking about, who can direct and move people into the space of saying 'actually I am going to go eco and it's not going to cost the world and it's very easy to manage'," says Underwood.

"We have clients that come to us who might have something in their mind. Such as a client who wanted a 52ft sailing yacht with a diesel engine. He spent 45 minutes with James aboard one of our hybrid yachts, and one of our fully electric yachts, and came away thinking 'no, I'll have an Oceanvolt with possibly a back-up generator'."

Like all traditional boatbuilders, this flexibility of adapting to changing decisions is key to Spirit's processes. As a custom yacht builder and designer, Spirit can be really flexible in build. Without the restrictions of moulds the company



Spirit Yachts are built in Ipswich. Credit: Spirit Yachts.



Credit: Spirit Yachts/Waterline Media

**“When you’re sailing, if you get prime conditions, you can really put a decent amount of power back into the yacht by using the re-gen through the propeller.”**

James Weller,  
head electrician, Spirit Yachts

can absolutely tailor all the systems onboard any of its yachts.

“We can produce what people want as we don’t have the moulds. The problem for some of the GRP manufacturers is obviously their production is restricted with their mould tools. They try and create a standard one size fits all package as ultimately they have to,” says Underwood. “If you are dealing with something that is coming out of a mould, ultimately there’s not much you can change to it in terms of economy of scale. If like

us you’re innovating throughout, it’s fine, you can have an electric 30 or an electric 111. We have the engineering capacity and electrical knowledge and knowhow to manipulate the hull to do what we’d like it to do, rather than the other way around.”

Weller says Spirit doesn’t just innovate at client request; he’s always looking at ways of powering yachts in the future. Currently he’s

investigating hydrogen fuel cells to see if there is potential in using synthetic fuels. “We’re constantly looking at ways we can improve the yacht scene further. It’s not as if we’ve gone to an electric drive system and gone ‘that’s it now’. We’re always looking to make better. Electric drives are great but still have drawbacks in terms of range and having to have lots of batteries onboard. We’re always looking at new options.” ■



# ASAP Supplies

Supplying you with the best products  
from industry leading brands





See us at Irish Skipper Expo  
Stand 64 | 24-25 Feb 2023

&

BoatLife  
Stand E42 | 16-19 Feb 2023



NEC | Birmingham | 16-19 February 2023



01502 716993 | info@asap-supplies.com | www.asap-supplies.com

**boot**  
Düsseldorf  
Visit us at BOOT Düsseldorf  
Hall 10 stand C18

# SAILING, SIMPLIFIED

**C** 5 min 10s

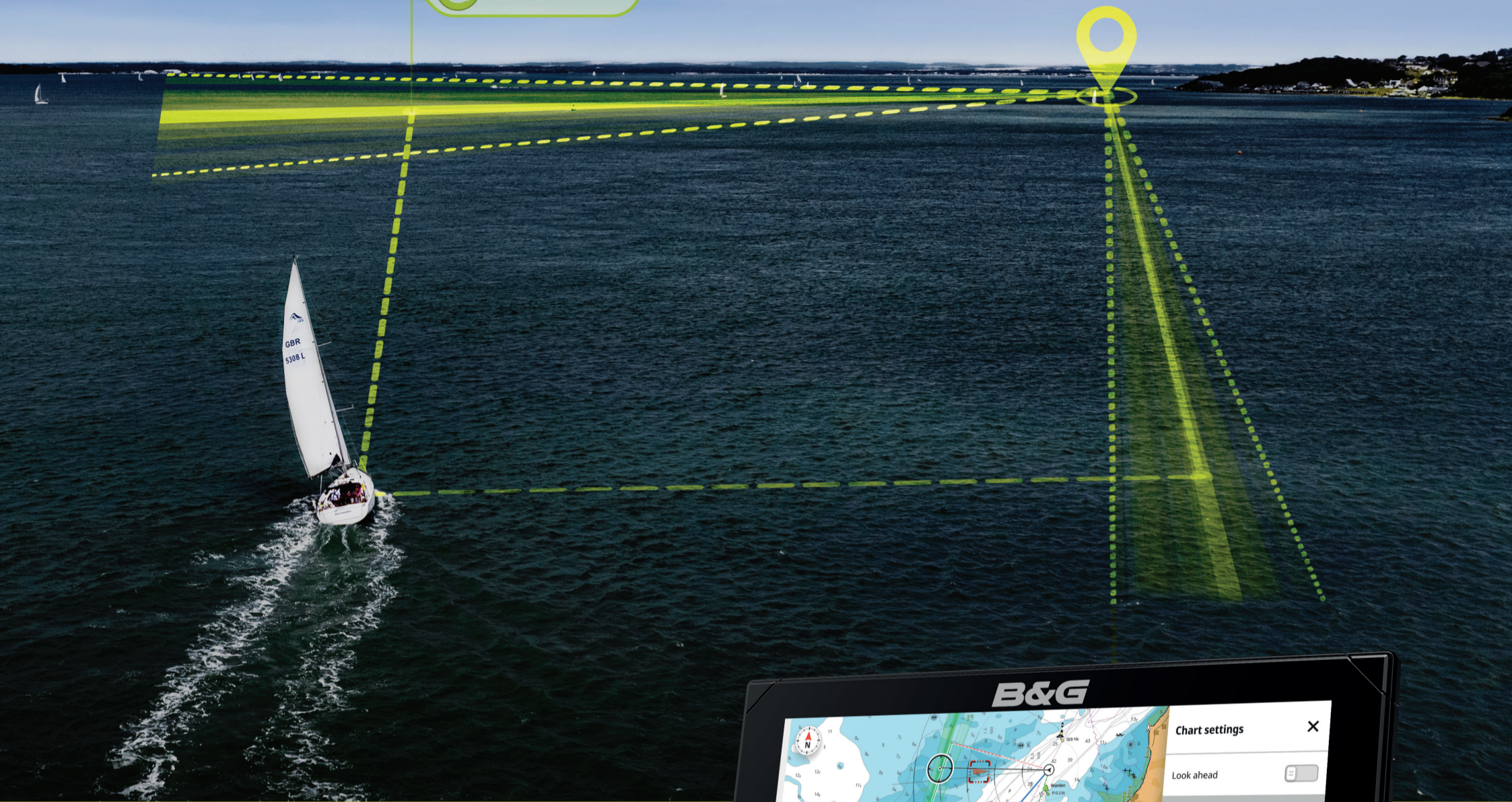

## NEW ZEUS<sup>®</sup> S

Zeus S is designed for simplicity. It all starts with brand new Sailing Modes for Cruising and Racing. Get instant access to all the right data for your situation.

Zeus S also brings updates and additions to B&G's award-winning sailing features like C-MAP<sup>®</sup>-powered Safety Alerts, race routes, Laylines and SailSteer<sup>™</sup>.

On-board navigation is taken care of by the highly-accurate C-MAP DISCOVER<sup>™</sup> X and REVEAL<sup>™</sup> X charts, and our intuitive new interface and Setup Wizard get you connected to all your on-board electronics in minutes.



AVAILABLE IN 7", 9" & 12".

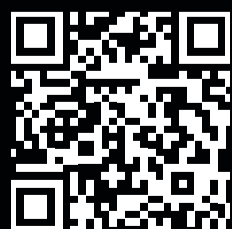

[www.bandg.com](http://www.bandg.com)

# B&G<sup>®</sup>

Marine Electronics for Sailing

# STOCKYKREPORT

## Market trends from Asia and the Middle East indicate growth potential

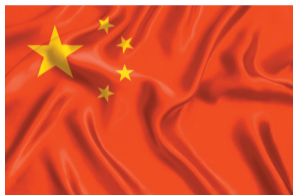

### CHINA | Godrey Zwygart

While leisure boating in China only started to expand ten to 12 years ago, several marinas are now in operation and there are more than 10,000 boats around the country. This is still ridiculously small compared to the size of the country, but there is tremendous market potential.

The main sailing hub is located at Hainan Island in the south, with 13 marinas currently operating. Sanya is the southernmost city on Hainan Island, where boat numbers have jumped from 600 registered boats to 1,000 in two years. Since June 2020, Hainan has become a free trade zone (FTZ) and free trade port in the making.

Several new measures have also been taken such as scrapping yacht import duties along with the introduction of a cap on taxes for enterprises and individuals in the FTZ. This will definitely give an enormous boost to the yachting industry and could be very appealing for foreign enterprises.

In terms of the boating demographic, boat ownership and boat usage is no longer the preserve of older entrepreneurs. Younger consumers are entering the boating market and represent a tremendous and ever-increasing potential for the future of China's yacht market, especially in the smaller boats and watersports sector.

Remarkably, China now has the highest number of ultra high net worth individuals (UHNWI) with 799 billionaires according to Hurun Report. Thus there is an expectation that the number of potential superyacht buyers could rise and this sector of the market should grow accordingly.

China's leisure marine market seems to be at a turning point. Awareness has grown following world race stopovers such as the Volvo Ocean Race and the Clipper Race. More recently, with prominent sailor Xu JinKun becoming the first Chinese sailor to participate in the Route du

**“[In China] Boat ownership is no longer the preserve of older entrepreneurs. Younger consumers are entering the market.”**

Godrey Zwygart, GMBA China

Rhum on an Open 60, which garnered even more interest.

However, the market has been hampered by Covid-19 restrictions (with Sanya experiencing two long lockdowns in 2022 alone). Additionally, there are still many navigation restrictions as well as a number of legal limitations, especially for superyachts.

Although we are not expecting a sudden boom in the yachting scene in the next year or two, it is worth keeping an eye on China's market potential, as the regulations will change step by step.



### SINGAPORE | YP Loke

In line with most countries, Singapore has transitioned to living with Covid-19. Being more cautious than most western economies, it is a half-step behind in opening up. The country is perceived to have managed the covid situation relatively well, helped by the strong social capital between the government and Singaporeans. As a result, Singapore has seen an influx of capital flight from around

the region. The wealth management sector has attracted many UHNWI to set up family offices here, with one result of this being many more big yachts on the water.

During the pandemic when travel was restricted (and lockdowns at home enforced for a period) people developed a pent up need to embrace the great outdoors. Like most countries, this drove people to buy boats when the floodgates were finally lifted. Demand for all forms of watersports (and course instruction) surged.

A new demographic was also driven to the water – a younger crowd, looking for smaller trailer-sized boats (not that you can trailer boats in Singapore – they must be stored in dry stack).

With life returning to normal and borders open, boating is again competing with the full suite of alternative activities for the consumer's leisure dollar. Anecdotal evidence is that the level of sales enquiries has dropped. However, most businesses remain busy and are still working to fulfilling existing commitments. Looking ahead, businesses expect trading conditions to be better than pre-covid times, but margins may be eroded by higher interest rates and inflationary pressure.

Many firms report a shortage of skilled manpower. Few Singaporeans are interested in working under the hot tropical sun, and boating has always been dependent on foreign labour, which is controlled by quota restrictions.

Businesses also report longer lead times for deliveries, resulting from global supply chain disruptions. With strong orders in their domestic markets, some manufacturers seem to have prioritised this over export markets which are more difficult to service, much to the disappointment of overseas distributors.

Despite uncertainty created by the risk of global tensions (Ukraine war, US/China trade tensions,



Russians moving to Dubai has led, in part, to more developments being built. Credit: Unsplash





Singapore skyline. Credit: Freepik

**With strong domestic orders, some manufacturers have prioritised this over export markets which are more difficult to service, much to the disappointment of overseas distributors.**

YP Loke, GMBA Singapore

global inflationary pressures, new covid mutations, climate change – to name a few) most marine businesses maintain a short-term optimistic outlook.



**MIDDLE EAST | Kai Malmivaara**

While European countries are suffering from rising electricity and oil prices, high inflation, the weakening of the Euro, and general rising uncertainty caused by the war in Ukraine, the Middle East countries, particularly GCC countries such as United Arab Emirates, Kingdom of Saudi Arabia and Qatar seem to be moving in the other direction. With the current oil prices the economies of these countries will receive a big boost, and as their currencies are pegged to the US dollar, their buying power is strong.

Traditionally when there is unrest in the world, UAE seems to be the safe haven for many people and assets. This also appears to ring true now as we see numerous people, including many Russians, moving to the region, and in particular to Dubai, resulting in real estate and rent prices soaring. This has also had an effect on the construction business, and many new waterfront developments have been launched, some of which also have marinas.

Qatar expected many superyachts to visit during the World Cup, and thus new marinas were built to cater for these boats. In Saudi Arabia, particularly in the Red Sea and Jeddah, there are many ultra large real estate developments like Neom, the Red Sea Project and Amaala Triple Bay. All these will have very sizeable marinas, which are built both for local people and for visitors. The plan is to attract yachts from the Mediterranean to come during the winter season to the Red Sea, Jeddah and Oman, and also to the Arabian Gulf, UAE and Qatar.

Many marinas in the GCC countries have a lot of vacant capacity, and the number of berths clearly

**The plan is to attract yachts from the Mediterranean to come during the winter season to the Red Sea, Jeddah and Oman, UAE and Qatar.**

Kai Malmivaara, GMBA Middle East



Firms in Singapore report a shortage of skilled labour. Credit: Freepik

exceeds the number of boats. In the UAE and KSA the bottleneck has been the lack of marine finance. In 2021, the Leisure Marine Association MENA was established in Dubai, with one of its main tasks to pave the way for boat financing. Good progress has been made with the authorities, and most likely financing with reasonable terms will be available for boat buyers in the UAE as well

as in Saudi Arabia soon. With new marinas emerging and financing for boats offered, there is a strong belief that the sales of boats will substantially increase both in the UAE and in Saudi Arabia.

The question is, are there enough new and used boats available in the leisure marine market to cater for this demand? ■ [www.gmba.blue](http://www.gmba.blue)



# WEST SYSTEM®



**“WEST SYSTEM epoxy does exactly what it says it will; yields immensely strong, durable bonds and makes the build stronger than it needs to be.”**

Spirit Yachts



Used on all Spirit Yachts since 1993



In build shots - Credit: Mike Bowden / Spirit Yachts  
On water shots - Credit: Spirit Yachts / Waterline media

**21-29 JAN 2023**



**STAND A23  
HALL 11**



Images credit: © Martina Orsini - Aerocet Moth GBR 10

**PRO-SET®**

**SOPHISTICATED  
EPOXIES FOR HIGH  
PERFORMANCE  
COMPOSITES**

**“Aside from the quality of PRO-SET products the level of support that we get is superb and reflects our own objectives when it comes to supporting our customers”**

Simon Maguire, Maguire Boats



**epoxycraft** READ OUR ONLINE PROJECT MAGAZINE FOR AMATEURS AND PROFESSIONALS

For inspiration, technical information and expert advice visit [www.epoxycraft.com](http://www.epoxycraft.com)

+44 (0) 1794 521111  
@wessexresins @wessexresins  
[www.wessexresins.co.uk](http://www.wessexresins.co.uk)

**WESSEX**  
RESINS+ADHESIVES  
THE UK'S HOME OF EPOXY

# Franchise opportunities launched with Freedom Boat Club EMEA



**The growing demand for shared boating access is increasing in popularity throughout Europe and the smooth transition from sole boat ownership to sharing a fleet of boats has gained great momentum in the past two years. Freedom Boat Club (FBC) franchise manager Leontien Moulijn shares her thoughts on questions that a Freedom franchise may raise for potential investors.**

## Why Freedom Boat Club?

Recognised as the oldest and largest boat club worldwide in its niche, the popularity of Freedom Boat Club continues to grow, with a current community of more than 80,000 enthusiastic members and 370+ superb locations. Those who are passionate about boating, seeking an enjoyable lifestyle and interested in owning a business with great potential may well find a Freedom Boat Club could be the perfect fit. We are actively seeking new owners who share our vision of making the boating life more accessible to all. Proof is evident in the growing roster of successful franchise owners and locations thanks to our globally proven and highly successful business model.

## Can you outline the support FBC provides?

Franchisees benefit from comprehensive support via the knowledgeable Freedom corporate team. With a range of innovative resources, available to both new and established owners alike, we ensure a smooth beginning and continued ongoing success. Making it easy to launch, manage and operate

a club, our proven business-in-a-box approach simplifies the entire process, with full support from the corporate team from on-boarding to recruitment and far beyond. Our recurring revenue model, minimal franchise investment requirements and wholesale boat financing options all add up to deliver success.

## Is there a new franchisee orientation scheme?

Absolutely, new franchisees participate in an intensive, multi-day training initiative that is designed to fully introduce all the FBC programs, systems and protocols. Franchisees train under the guidance of corporate experts in sales, marketing, operations and technology with an array of topics covered including membership sales, fleet and dock operations, management training and safety procedures

## What can members expect from a Freedom Boat Club?

Freedom Boat Club members enjoy access to a wide variety of boat types in the local fleet, selected by the franchisee, according to regional boating preferences and water conditions. All new members receive free initial and ongoing training by captains from the Freedom Boat Club's proprietary classroom and 1:1 curriculum. Full maintenance, cleaning, repair and storage is handled by each club, along with registration and insurance for the boats. Members enjoy four rolling advance reservations, which can be made via the mobile app or online reservation system plus they can take out a boat at any other Freedom Boat Club location through the well-established reciprocal programme.



**Are you passionate about boating and always wanted to be your own boss?**  
Then a Freedom franchise could certainly be the perfect fit. Please send your application to:  
**[www.freedomboatclubfranchise.com](http://www.freedomboatclubfranchise.com)**  
We look forward to hearing from you.

# TMS

# TECHNICAL MARINE SUPPLIES

Specialist Marine Trade Distributors  
[sales@technicalmarinesupplies.co.uk](mailto:sales@technicalmarinesupplies.co.uk)  
01752 600454

## SELDÉN



### Seldén - CXe45

New for 2023, Seldén have launched a new addition into their SEL-Bus Range of 42v products; the CXe45. The CXe45 is a new electric Code 0 furler allowing sailors to quickly furl away their sail at the push of a button, from the comfort and safety of the cockpit. The CXe45 can be a standalone upgrade to a vessel, or a very simple and easy addition if the vessel already has other Seldén SEL-Bus equipment, such as Furlex Electric, Electric In-Mast Furling, or the E40i Winch onboard. All of the Seldén SEL-Bus electric systems are also now comparably more affordable compared to electric systems of old thanks to the shared Power Supply Unit, and advances in power management and electrical technology. The complete SEL-Bus system now allows you to furl away your Code 0, Headsail, and Mainsail, with the E40i winch offering an electric coach-roof winch with zero impact to headroom.

The E40i winch can also be configured alongside the in mast furling to provide Seldén's "SMF" or, "Synchronised Main Furling". This is where at the push of one button, the E40i winch will tension the outhaul, at the same speed that the in-mast furling unfurls giving you more sail.

### Simarine - Nereide 3 Vessel Control Panel

The new Nereide 3 vessel control panel from Simarine boasts a huge amount of features, and is creating quite a stir across Europe with its fully customisable digital label suite. Using the dedicated software, the N3 allows us to fully customise your switch panel to your exact requirements prior to delivery. A great feature that allows the digital age to assist with minimising lead times for our OEM clients.

Not only does the N3 utilise the remote DC switching nodes enjoyed by many Nereide 2 boatbuilding customers in Europe, it also sees the launch of the remotely operated motorised AC breaker node, which allows for a remote reset via the panel. Coupled with the integration of the well renowned PICO, and a navigation light display, the N3 is taking the UK boatbuilding industry to the next level of vessel / client integration.



SIMARINE



### Sertec Marine - Lightning Prevention

Every time we go sailing, we look to enjoy our time on the water, and do so safely. Many risks can be easily mitigated or planned for – but the event of a lightning strike has typically been much more difficult.. UNTIL NOW! Sertec have produced a dedicated marine spec system to not only protect against lightning strikes, but also provide real-time monitoring of the effectiveness of the system.

The Sertec CMCE provides permanent protection from lightning strikes by balancing and deionising the effects of atmospheric phenomena using one or more compensators. By stabilising the existing electric field in its environment, it creates a 'shield' that cancels the formation of the ascending tracer by draining the electric charges to the earth or surrounding water in harmless milliamperes. This eliminates the formation of lightning within the protected area. This system can be easily monitored using the Sertec Storm 7 device – which continually monitors the local atmospheric conditions, and the drain charge. Storm 7 can trigger alarms if the ground connection were to be disturbed and produce an annual report which may be looked favourably upon by insurance companies. Sertec are proud to be an ISO 9001 & 14001 organisation, and meet many other certifications and accreditations including CE, UKCA, NATO, along with full accreditation by the Nicola Tesla Institute.

### Sentinel - BM50 Boat Monitor

The Sentinel range of Boat Monitors are exclusive to Technical Marine Supplies for the UK market, and 2023 sees the launch of the BM50, an all-new Telematics Control Unit (TCU). The BM50 takes telematics to a new level, offering a full stack of telematic solutions to boat builders, service personal, and skippers alike. The TCU is a communication gateway for remote monitoring and circuit switching.

The BM50 itself does not integrate a User Interface, instead this is achieved through customised applications designed with different levels in the connected boat ecosystem, offering for instance a different level of information for the boatbuilder to what the service partner or vessel operator would see. OEM customers can also benefit from having the hardware of the BM50 installed within the Nereide 3 panel from Simarine, offering a complete full remote monitoring and switching system to the customer.



SENTINEL  
Marine solutions



### Bonomi - JOY Self Tailing 204mm Cleat

The Bonomi Self Tailing Cleats can easily be considered game changers in today's marine market. The Bonomi cleats remove the requirement to have a capstan fitted for tensioning mooring lines, and makes the whole process of mooring up an easier and safer affair, particularly when mooring stern-to. Having initially focused on larger vessels and superyachts, the range now features a smaller unit, with an overall cleat length of 204mm, and rated to a pull of 80kg. The addition of this smaller model opens this technology to vessels under 50' LOA.

Using the cleat is as simple as passing the mooring line through the fairlead on the boat, over to the cleat and round. Actuate the motor with a foot switch, and once the desired tension is met, simply make off on the cleat. At no point do you need to risk injury to transfer the load of the mooring line from a capstan to a separate dedicated mooring cleat/bollard.

### Tikal - TLB Flex

TLB Flex is an area-adhesive for bonding teak-decks, cork-decks and synthetic (PVC) decks on top of all yacht surfaces. With TLB Flex, your chosen deck material can be glued to the top of the vessel's deck, regardless of whether it is GRP, wood, aluminum or steel. TLB Flex hardens under the influence of humidity to a permanently flexible mass, offering an industry leading flexible bond between your chosen finish and the deck below. TLB Flex is an elastic, one-part area-adhesive based on SMX hybrid polymer, therefore isocyanate and solvent free, and carries an 18 month shelf life.

New to the range for 2023, the TLB Flex Primer offers the best bond between the proven TLB Flex and synthetic, PVC decks that are becoming more common, ensuring a complete bonding solution.

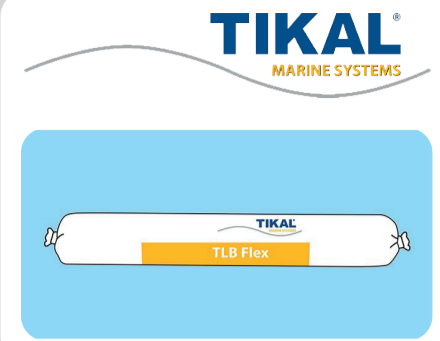

### THE Q EXPERIENCE



### Q Display

If you are looking for a vessel interface which incorporates a chart plotter, digital switching system, entertainment system, and display for fish finder, radar, cameras, then the Q Display is fast becoming the industry choice for those in the know. The Ultra HD display from Q is fully programmable and customisable to your brand and vessel requirements. The sizes available now range all the way from a 10" up to a 24"! All sizes can be configured as master and slave systems if you need multiple displays, and for a truly seamless dashboard on the smaller vessels there is a dual 10" unit.

The Q Display supports Navionics+, with users commenting over and over about the display's speed across the charts. For OEM installers there are over 200 measurable data points that can be learnt from individual vessels. Allowing you to better understand how your vessels are being used and make improvements over time.

### UNITECK



### watt&sea



### SILENTWIND

the blue blade turbine



### SIMARINE

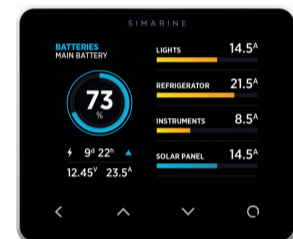

### Uniteck (New MPPT UK Launch) / Watt & Sea / Silent Wind / Simarine

Newly released for 2023 is the new UNIMPPT Solar Charge controller from **UNITECK**. Its ALGOTECK 6 charge curve, unique on the market, tests your battery, recharges it to 100%, disulfates it, maintains its charge and improves its lifespan, while taking into consideration the technology of your battery and the ambient temperature to adjust its voltage thresholds according to the recommendations of the battery manufacturer. Using MPPT technology, UNIMPPT also uses the entire panel voltage by converting the excess panel/battery voltage, not used by a standard regulator, into charging current for the battery. Featuring a screen which offers precise monitoring of your solar installation and battery charge, via its controlled 12/24V output. This now becomes part of a bigger system of renewable energy, reducing your requirement for the running of generators. Even on the heaviest power consumers, using the three pronged approach of **Uniteck Solar**, **SilentWind** wind generator, and **Watt & Sea** Hydrogenerator, you may find you don't need to run conventional generators at all! This could all be jointly monitored using the **Simarine** Pico Battery Monitor – giving you a full and detailed picture as to what power is being used and generated where, how much power you have left, and help you optimise for full autonomy from fossil fuels.

### EGIS MOBILE ELECTRIC



### EGIS Mobile Electric - XD Series Programmable Relays

The 2022 IBEX Innovation Award winning XD Series High Amp Remote Relays are available in Single XD, Dual XD and Triple XD configurations. When combining a Triple XD with one or more Dual XD, an OEM/installer is able to configure all necessary battery disconnect switching, automatic charge management, and emergency parallel in a simple manner with standard busbars and minimal space, time, and cost. Perfect for a typical dual-battery boat, the XD Series Triple Flex Relay combines three independently controllable, high amperage relays to reduce installation space, weight, time, and total cost by up to 70%. Each relay's automatic or remote response profile is programmed via integrated dip switches under a sealed cover allowing each relay to act as either a simple remote relay/battery switch or an automatic charging relay.

### RT Series Fuse Blocks and Circuit Breakers

Ensure reliable electrical system circuit protection with Egis Mobile Electric's RT Series fuse blocks that offer LED blown fuse indication, protective cover and two spare fuse slots per six fused positions. Ring / screw terminal design offers enhanced electrical connections. The robust RT Series fuse blocks are designed as a modular / connectible system that is configurable from a 6-position fuse block or 12 position ground busbar up to a 18 position fuse block with integrated ground bus, allowing builders to need to stock only two main components if desired. Transparent protective cover with recessed labels spaces enables easy identification for servicing and identification efforts. Pair these amazing fuse blocks with Egis Mobile Electric's surface and panel mount circuit breakers that offer IP67 ingress protection, UL 1500 ignition protection, stainless steel self locking hardware and high visibility reset switch. These circuit breakers protect electrical circuits from thermal overloads and provides reliable live circuit manual switching for your electrical system.



Come and see us on Stand G50  
NEC | Birmingham | 16-19 February 2023

Specialist Marine Trade Distributors



# QUALITY MARINE EQUIPMENT



Photo credit | Oyster Yachts



## Commercial & Leisure Marine Specialists

C.Quip deliver exceptional quality stainless steel, lighting, marine hardware and fittings.



### Suppliers to:

- Boat Builders
- Boat Yards
- Marinas
- Chandlers
- Riggers

VISIT OUR NEW WEBSITE

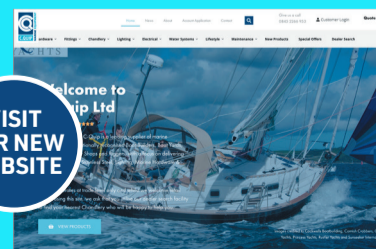

SCAN ME

+44 (0)845 2266 953 / 954 | [info@cquip.com](mailto:info@cquip.com) | [www.cquip.com](http://www.cquip.com)





Credit: Marc Wieland/Unsplash

Words: Gemma Harris

## CEO of Barton Marine, Suzanne Blaustone, discusses the company's US growth plan as it balances the ongoing obstacles marine businesses are facing

With the aftermath of Brexit and a global pandemic, and catastrophic global political and economic shifts, it is safe to say the environment hasn't been the kindest to marine companies. But, besides these challenging ups and downs and the inability to predict what is around the corner, UK marine equipment company Barton Marine continues to steer ahead.

Suzanne Blaustone, CEO of Barton Marine, says: "Satan himself is driving the bus right now. Business leaders can no longer just manage and lead our companies forward anymore; in the last three years, we have developed into being crisis managers."



### Navigating the 'new normal'

"Since 1948, our complete range is manufactured, produced, assembled, and dispatched from Kent; the company has had three owners, all of whom were/are dedicated to keeping production in the UK; we are extremely proud of that as we can control materials, quality, and processes," explains Blaustone.

With 60 per cent of Barton's business landing in Europe, Brexit was a huge hurdle. "Barton Marine is solidly and firmly against the Brexit decision. I am proud to say we haven't lost a single customer in Europe, but we were prepared and did our due diligence.

"We initiated a Euro price list so customers would always know their pricing despite exchange rate variables over time. We outlined our training

preparation programme for changes in freight and tariff issues and reviewed our tariff codes to ensure proper and least offensive codes were used so that they were reported correctly."

Preparing and navigating the Brexit fallout was crucial and the company aimed to ensure it

wouldn't be blindsided even if the business landscape shifted dramatically following Brexit. "We outlined our plan and put in the groundwork to open a warehouse and office in Belgium should final exit plans create such havoc - but in the end, we did not need to do this as it was more economical to operate from our



UK base, which helped stabilise costs,” explains Blaustone.

As the dust settled on Brexit, like everyone, Barton Marine faced a global pandemic. “We never closed Barton Marine; we were an essential business and stayed open through the pandemic,” Blaustone says. “With Brexit, I saw the supply chain issues possibly tightening up, so we were already supplied with raw materials throughout the pandemic. We had the supply; we weren’t devastated by these issues and could jump forward with new supply programmes.”

**Expansion plans**

Barton’s pre-planning ahead of supply chain issues and new staff hires is crucial to its momentum.

“We have expanded our team recently, with a new chief operating officer in the US and a new chief commercial officer here in the UK. I have developed a team with strong leadership; I wanted to recruit more sailors and youthful people within Barton,” Blaustone adds.

Barton is now looking at the younger consumer generation entering the leisure marine space.

“We are focusing on getting into schools and universities and supporting younger sailor programmes. We want to see more young people on the water; it is important that a new sailor grows up seeing Barton Marine equipment on their dinghies,” she says.

**“We want to make more partnerships within the outdoor recreational sailing and boating industry to create synergies with other companies that can grow, and maybe create a new product together.”**

Suzanne Blaustone, Barton Marine

The younger generation is a prime target group for the US expansion, which John Navarro, the newly appointed COO for Barton US, is managing.

Navarro says: “My first step is the college and university market space in the US; many colleges and high schools have sailing programmes.”

Diversifying and innovation are essential to Barton’s values; Blaustone explains: “We are part of a larger movement; instead of us looking at one sport, it’s becoming about the outdoor leisure lifestyle with sailing and watersports being just one part of that.

“We want to make more partnerships within the outdoor recreational sailing and boating industry to create synergies with other companies that can grow, and maybe create a new product together.”

In terms of future partnerships, Blaustone nods to opportunities across multiple industries, where Barton’s in-house manufacturing and R&D can help bring new, bespoke products to market.

She says: “We are able to create bespoke products for workboat and RIB designers, and with companies in the industrial markets for gym equipment, warehouse equipment and safety riggings for man-

overboard, elevated ‘high wire’ and ground hole rescues.”

**2023: a year of challenges and opportunities**

As the marine industry enters 2023, talk of recession and global economic shifting sands is never far away. “We are going to see some devastating times for some companies; I have heard statistics that we will lose marine companies because they won’t be able to withstand a recession,” says Blaustone. “But this is not the time to draw your reins in. Our tight-knit team is pulling together, and we are expanding; our image, our exposure, and sales further worldwide, which will help us throughout the recession period.”

Concrete longer business plans in such unsettled times are... tricky. “My grandfather used to say when you are up to your ass in alligators, it’s hard to remember your job was to drain the swamp,” Blaustone jokes. Yet aside from anecdotal light-heartedness, Blaustone takes her responsibilities and priorities seriously. “We have 30 families to support here, and that always comes first to me,” she says.

In terms of future challenges, Blaustone echoes that of many business owners: “Energy will continue to be our biggest challenge, with the brown-outs and black-outs. Our energy company told us our increase would be 283 per cent; we negotiated that down to a 97 per cent increase. We have

**“This is not the time to draw your reins in. Our tight-knit team is pulling together, and we are expanding; our image, our exposure, and sales further worldwide...”**

Suzanne Blaustone, Barton Marine

already put a backup generator in place and will review different procedures, such as putting in a night crew if there are brown-outs during the day.”

Sticking to her own advice about not drawing the reins in during this era of business challenges, Blaustone confirms there are plans for Barton Marine to expand further while still providing its current customers with continued first-rate service.

Navarro weighs in on their current US plans: “We are on the cusp of becoming a global player; within the next two years, the goal is to have a very strong, maybe up to a five-person team in North America to coordinate all our efforts in North and South America.

“We’ve had little representation in North and South America, so every new customer is important because they are new, one of many to come. We are the unknown, and I think this is key to our expansion, being the unknown and becoming known,” he says.

For now, Barton Marine focuses on controlling what it can and continuing to navigate well through new challenges, using an adaptable business ethos and employing flexible solutions to overcome hurdles.

Blaustone concludes: “We want to hold on to our current customers and make sure we can service them to the highest degree, which has always been our ethos here.” ■







**PALMA  
INTERNATIONAL  
BOAT SHOW**

**PALMA**

**SUPERYACHT  
VILLAGE**



27-30 April 2023 • Palma de Mallorca, Spain



*Come and Discover* **YACHTING**



*Enjoy* **LIFE**



*Visit* **PALMA**

Follow us



Perfectly timed before the Mediterranean summer season:



# STERK

sterk[sterk]  
*adjective\**  
 firm, sound, or powerful, and therefore not easily broken, destroyed, attacked, defeated, resisted, or affected by weariness, illness  
 \*https://dictionary.cambridge.org

sterkyachts.com



World Premiere  
 boot Düsseldorf  
 Hall 4 D59

# 31

#the\_Beauty\_in\_the\_Beast

Design by   
 Carlos Vidal



21-29 Jan 2023  
 boot.de boot.com

HSXV Premium  
 Vectran® Hybrid - Grey.

## Bainbridge Sailcloth

Premium Vectran® Hybrid

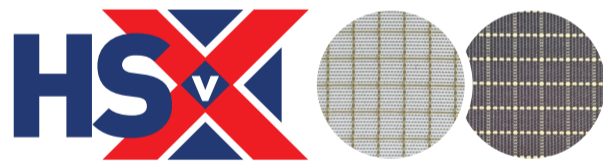

Vectran® ripstop construction delivers an incredibly strong hybrid cloth with UV protection.

Premium Polyester

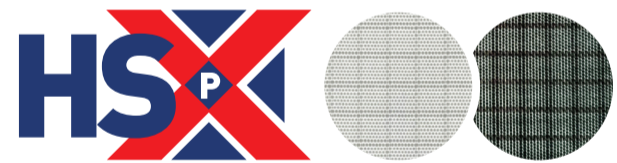

Available in 3 styles and 2 colours – Ripstop, Strong Fill and Strong Warp, White and Grey.

## Cover Fabrics

### Solacryl

Premium Marine Acrylic

- Appearance of traditional cover
- UV and fade resistant
- Mould and mildew resistant
- Range of rich colours
- 5 year warranty

### SolaTX

Technical Xtreme Outdoor Fabrics

- Ideal for sprayhoods, biminis, and dinghy covers
- Low weight, breathable and watertight
- Xtreme strength and tearing resistance
- 1.92m full width for maximum cost savings and reduced seam requirements



Bainbridge

T : +44 (0)1489 776000  
 E : info@bainbridgeint.co.uk  
 W : bainbridgeint.com  
 facebook.com/bainbridgeint



The technology is used in every new model evaluation, allowing Sunseeker's designers to understand the feeling of space and visualise features before construction begins.

# New reality

Sunseeker integrated VR into its design process in 2021. Credit: Sunseeker

## How is virtual and augmented reality changing boatbuilding, design and ownership?

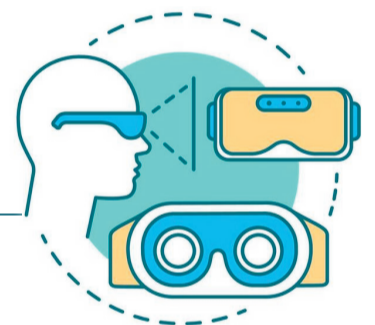

According to a recent report by Gartner, 25 per cent of consumers in the US will spend one hour daily in the metaverse, shopping, socialising, being entertained and learning by the year 2026.

"Vendors are already building ways for users to replicate their lives in digital worlds," Marty Resnick, research vice president at Gartner, reported in 2022. And marine businesses are no different, with boatbuilders, safety companies and product manufacturers adopting the technology to improve their output.

XR or 'extended reality' is an umbrella term that encompasses virtual, augmented and mixed reality ecosystems. Virtual reality (VR) aims to create a sensory experience for the user, simulating their presence in that virtual space, while augmented reality (AR) projects visuals into their environment providing a new perspective of the existing space.

### Sunseeker and VR

During the build phase in boatbuilding, XR can be used to eliminate potential errors and design flaws with a virtual 'twin'. This virtual mock-up essentially enables vessel architects to gain a deeper, more thorough understanding of their designs prior to materialisation.

Sunseeker integrated VR into its design process in 2021 and works with Siemens NX to deliver its VR capabilities. The Superhawk 55, 65 Sport Yacht and Predator 65 have all benefitted from VR to guide the design process from concept to realisation.

The technology is used in every new model evaluation, allowing Sunseeker's designers to understand the feeling of space and visualise features before

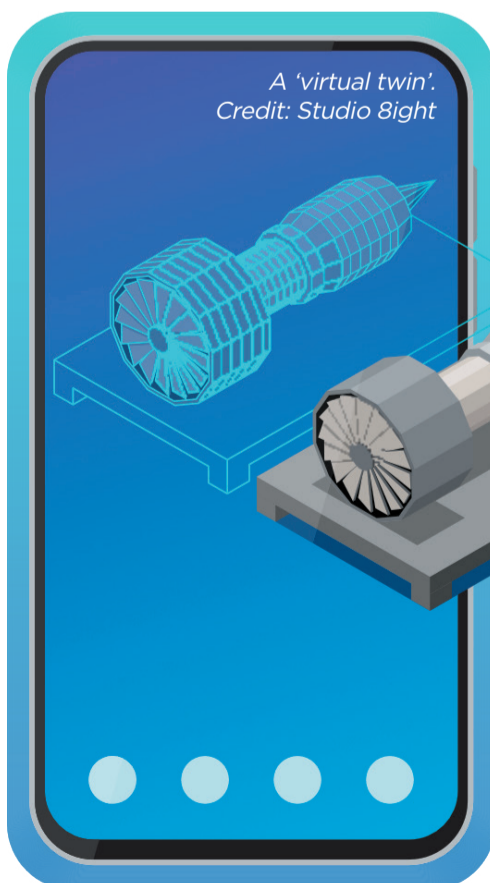

construction begins. Ewen Foster, chief technical officer at Sunseeker International, says: "We have integrated VR into our design reviews where the relevant expert in production can interact with systems, engineering, interior furniture and control interfaces allowing for streamlined cross-departmental collaboration and improving the overall build efficiency."

### Boat design VR

Foster says VR has replaced the very time-consuming and resource-intensive process of making plywood mock-ups built to scale.

"Any modifications would take time to bring to fruition, and wood waste would be a prevalent by-product of this process. Using VR allows Sunseeker to make design changes immediately, improving the overall efficiency of the process and reduces waste," says Foster.

Leading powerboat builder Axopar also uses VR in the design and engineering stage. "VR helps visualise how individual spaces can be used to their best effect," says Jouni Huusko, head of design at Axopar.

"It helps us to predict how customers will interact with their boat, both on deck, but mainly inside the cabins and living spaces, where we can make adjustments and improvements accordingly.

"With the headset on, we can step inside the boat and get a similar sensory experience to the one our customers will receive when the boat is built," Huusko continues.

"With VR we can see where potential pinch points, such as corners and junctions will play out, when a person is physically moving throughout the space. Good ergonomics in the area of the dashboard layout and the helm position, for example, is critical for us, both in terms of driving enjoyment and for safety."

The technology is also helpful for checking accessibility to locations on the boat where maintenance is needed. "We can use VR to stretch out our arms and see how easy or difficult it is to hold things and pick things up and place them down from a seating or standing position," adds Huusko.

"Instead of trying to 'second-guess' what we think our customers will need, we can take these assumptions to a more scientific

**“VR lets the customer take a good look around and decide exactly what cabin choice and interior layout will best suit their needs. They can switch between designs and make their choices almost without leaving the stand.”**

Jouni Huusko,  
head of design, Axopar

level with a full-on 3D experience that gives a greater sense of assurance at the design stage. As soon as the basics of the design have been entered on to the VR software, it's a quick process to make any further changes to the design we need.”

**Virtual marine training revolution**

Jameel Rahaman, lead producer and founder of XR development studio, Studio 8ight, says environment simulation, marine training and troubleshooting is an area that can benefit hugely from XR technology. “Crew may engage in a spectrum of simulations from manoeuvring on the bridge wing to installing diesel electric generators all while avoiding costly errors,” says Rahaman.

In safety training, for example, XR technologies could enable crew to experience high risk scenarios or train for difficult maintenance tasks while remaining perfectly safe within a virtual construct.

“XR technology can also heighten user engagement by neatly summarising information. Imagine replacing or servicing parts on a generator using the technical documentation versus using an XR capable device that presents just the relevant details in a digestible format for completing the task at hand,” he adds.

**Marketing in the metaverse**

XR's potential as a marketing tool is increasingly being adopted by brands competing in crowded markets. “Delivering a host of information which is typically still done through lengthy brochures or flipping through photographs online or watching a video walkthrough is nowhere near as compelling as XR, which can enable a customer to virtually visit the vessel in real-time, allowing potential clients to experience a boat, layout or particular model for themselves,” says Rahaman.

Sunseeker most recently utilised VR at the Superhawk 55 Experience, an experiential event for customers at the company's showcase facility in Poole, Dorset. Sunseeker launched the interactive space for customers to explore the new Superhawk 55 during the very early stages of the build. Along with full-scale general arrangements on the buildings floor and walls, a full

display of interior finishes and a factory tour of the first hull in-build, Sunseeker used VR to help bring the yacht to life.

Sean Robertson, sales and marketing director at Sunseeker International says: “Altogether, the immersive experience helped clients to gain a deep understanding of the yacht and build excitement before its upcoming highly anticipated launch at boot Düsseldorf 2023.”

Axopar was one of the first to have a VR headset on its stand at major boat shows and utilises the technology as a form of market research – to gauge customer reaction to a proposed new model that might still be years away from reality.

“Later, when we come to launch a new boat, VR lets the customer take a good look around and decide exactly what kind of cabin choice and interior accommodation layout will best suit their needs. They can switch between the experience offered by different interior and exterior designs and make their choices almost without leaving the comfort of the stand,” Huusko explains.

**On board life enhancers**

While not a new technology by any means, XR development firm Studio 8ight identifies 360 footage as a route for new possibilities for the leisure marine sector. “Opportunities in this sphere abound because the marriage of wonder and convenience is so attractive. Say an owner of a vessel would like to undertake a dive with their family or friends in a nearby bay but is unable to do so for one reason or another. You could take an underwater drone, mounted with a 360 camera and capture the experience, afterwards formatting it for use on an XR device,” says Rahaman.

Today the various XR head mounted displays (HMDs) on the market are still a bit cumbersome but headsets are only going to become more lightweight and versatile with every future iteration. Rahaman notes that advanced haptics (touch technology) and eye tracking systems are also being integrated into newer HMDs allowing for more performant and immersive experiences. “I expect most of us will enjoy

**“You could take an underwater drone, mounted with a 360 camera and capture the [scuba diving] experience, afterwards formatting it for use on an XR device.”**

Jameel Rahaman,  
founder, Studio 8ight

spectacle-sized XR technology within the next decade,” he adds.

In terms of future applications within its business, Sunseeker is open. Foster says: “VR offers many collaboration opportunities within the business. Warranty, quality and production departments all benefit from reviewing the design with VR, understanding the assembly in detail, and creating an immersive experience to realise a collective vision. There are fantastic future applications, including service and new model

training for Sunseeker's global distributor network.”

As tech ramps up, businesses that do not at least consider XR uses could fall behind competitors. “Extended reality is not a distant future, it is an omnipresent, desirable tool for both business and entertainment,” Rahaman says. “With the benefits of these technologies in plain sight, the question to ask is not whether to adopt XR, but rather, how soon?” ■



Axopar has widely adopted VR throughout the business. Pictured: Axopar 45 XC



Sunseeker design phase



Sunseeker's Poole facility, UK

# SPECIALIST MARINE COMMUNICATIONS

- design
- public relations
- crisis comms
- media buying
- digital advertising
- social media
- content creation

# maa.

maa.agency | info@maa.agency | +44 (0)23 9252 2044

**A-plan**  
insurance  
// a howden company

**commercial marine**

Expert advice  
Specialist knowledge



**Contact the experts**

Tel **01905 930760** | [www.aplan.co.uk](http://www.aplan.co.uk)

email [worcestercommercial@aplan.co.uk](mailto:worcestercommercial@aplan.co.uk)



## Midland Changers

### The UK's No. 1 for Canal & Narrow Boat Equipment

[www.midlandchangers.co.uk](http://www.midlandchangers.co.uk)

**SBS BoatLife**

NEC | Birmingham | 16-19 February 2023

**See us at BoatLife**

Speak with the team to see how we can help with all your boating requirements

**Stand C40**  
16-19 Feb 2023



☎ 02476 390111

✉ [sales@midlandchangers.co.uk](mailto:sales@midlandchangers.co.uk)

# Top Gear



## Revolve Emergency Marine VHF Antenna

This DAME award nominated high-performance emergency VHF antenna with AIS compatibility is based on a proven Rolatube design developed for, and in use by, the military. The patented design integrates an antenna into the IPX7-rated rollable composite material, removing the need for separate mast and antenna units and reduces equipment count and setup time.

The antenna has a high-vis cover with an integrated SOLAS-approved LED strobe for location assistance. When needed, it unrolls in seconds to form a 2.5m long, high performance VHF antenna for use in situations when primary communications equipment is not operational.

Tuned to channel 16 with AIS compatibility, the rollable emergency marine antenna is compact, light and portable.

[www.seaviewprogress.com](http://www.seaviewprogress.com)



## Icom IC-M510E

Icom's DAME Award nominated IC-M510E advanced marine VHF/DSC radio allows a user to control and operate wirelessly from a smartphone. The radio comes in two versions; a VHF only and a VHF with built-in AIS receiver.



The IC-M510E is almost half the depth of its predecessor, the IC-M506E, and has a 3.5in LCD colour display and wide viewing angle for improved readability, even in low light. It also features a night mode.

Front and rear connection ports allow an additional HM-195GB remote command mic/handset. Users can connect up to three smart devices via its built-in WLAN using the free RS-M500 iOS/Android app. Add the optional CT-M500 interface unit to gain NMEA2000 connectivity and a two-way hailer/PA function and foghorn.

[www.icomeurope.com](http://www.icomeurope.com)



## Atmos

Atmos, by Scanstrut, is a built-in air station designed to maximise a boater's quality time out on the water. At the push of a button, Atmos is ready to inflate (or deflate) paddleboards and towables – with users simply setting the target pressure.

Atmos features Scanstrut's next-gen air pump technology. To install, owners can fit the Atmos into any shallow cavity on board; seating, consoles, or even into the hull. The unit is then wired into the boat's 12V circuit.

[www.scanstrut.com](http://www.scanstrut.com)

# ATMOS



## Egis XD Series Flex 2 Relay

Egis Mobile Electric introduces the new Flex 2 variant of the XD Series high amp remote relay products. Any relay in the single, dual and triple circuit variations can be configured as a fully adjustable automatic charging relay with the new Flex 2. The charge management algorithm eliminates ACR cycling when connecting deeply discharged larger batteries and smaller engine batteries to charging sources. When combining a triple XD Relay with one or more dual XD Relays, an OEM/installer is able to configure necessary battery disconnect switching, automatic charge management, and emergency parallel with standard busbars and minimal space, time, and cost. The modular approach innovatively allows minimal stocked products to support two or more battery banks without introducing complexity in install, remote control, or configuration.

[www.egismobile.com](http://www.egismobile.com)



## ProMariner ProTournamentelite

ProMariner's ProTournamentelite series provides a competitive battery charging edge designed to get boaters out on the water first with power to last. Incorporating three patent-pending features not yet seen in the industry, the new Navico Group ProMariner ProTournamentelite series battery chargers include a charge status AC glow plug, power flow cooling and turbo charge capabilities.

According to the manufacturer, fully automatic five-stage charging significantly improves battery performance while extending battery life with five sequential stages: analysing, charging, conditioning, auto maintain (energy saver) and a once-a-month storage recondition mode that is safe for short and long-term storage. ProTournamentelite's distributed-on-demand charging technology uses 100 per cent of the available charging amps and distributes them to any one battery, or a combination of all batteries (up to 18 amps per battery), as needed.

ProMariner has incorporated all these features into three global models with worldwide AC input and a CZONE NMEA 2000 interface for connected systems, providing charge status on board for slipped boats.

[www.promariner.com](http://www.promariner.com)

# WELCOME ONBOARD!

## BOATING MADE SIMPLE



If you're passionate about boating, looking for an enjoyable lifestyle and are interested in owning a business with real growth potential, Freedom Boat Club is the perfect fit.

The Freedom Boat Club Franchise is a shared boat access program that offers its members a hassle-free boating experience, offering reciprocal access across the world.

No other boat club franchise offers its members such a great lifestyle on the water with a wide-range access to boats and training on a global level.

We have grown to be the largest network of boat clubs worldwide with over 370+ global locations and over 80,000 members with ambitious plans to expand across Europe.



Who ever said you can't combine work with pleasure?

Are you passionate about boating and interested to start your own company in the leisure boating industry?

If yes, get in touch for more information:

**Leontien Moulijn**

EMEA Franchise Development Manager

**Freedom Boat Club**

leontien.moulijn@brunswick.com

[www.freedomboatclubfranchise.com](http://www.freedomboatclubfranchise.com)

**BRUNSWICK™**



# INNOVATION FOR EXPLORATION



At Raymarine, we are constantly innovating to deliver intuitive and easy to use marine electronics systems so your time on the water is stress-free, safe and fun. From chartplotters, to instruments, connected boating, and radar, with Raymarine you can be confident we have the right navigation system for you.

**Raymarine**

#FindYourSea